

ISTRUZIONI D'USO TEMPLATE – SCATOLA TEXAS

ISTRUZIONI

QUANDO APRIRAI IL FILE DEL TEMPLATE TROVERAI TRE LIVELLI DI LAVORO

1
LIVELLO " TEMPLATE ":

Lasciare il livello bloccato.

IL LIVELLO INCLUDE:
A

LINEE DI TAGLIO:

Linee di taglio, mantenere tutti gli elementi grafici importanti 3mm all'interno della linea di taglio.

B

LINEE DI PIEGA:
C

ABBONDANZA GRAFICA:
2
LIVELLO YOUR DESIGN:

Inserisci la tua grafica in questo livello, l'interno della linea verde, corrisponde all'abbondanza dell'area stampabile.

DESIGN:

Il file deve essere in formato vettoriale.

- Il file deve essere inserito entro l'area di sicurezza. (example) **D**

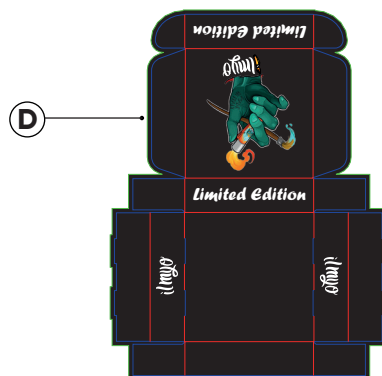
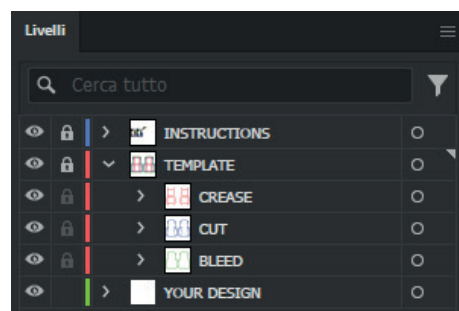
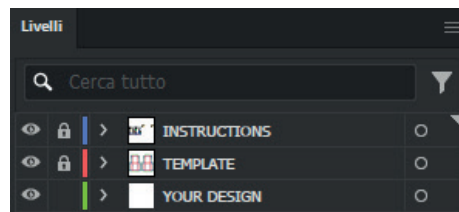
GRAFICA:

Nel file inviato la grafica deve essere vettoriale o, nel caso di immagini, devono essere allegare o incorporate nel progetto finale.



Nel caso di immagini PNG consigliamo un formato PNG con 300 DPI.

COLORE:

 È possibile stampare solo in **CMYK**.

TESTO:

Se è presente del testo nel tuo progetto devi convertirlo in tracciato o allegare i font.

FORMATO DEL FILE:

Salva il file in PDF, in alta qualità

- È importante mantenere separati i livelli **TEMPLATE** e **YOUR DESIGN**

 Invia i tuoi file PDF, EPS, AI, PSD, JPG, PNG a: commerciale@ilmyo.it

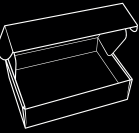

TEMPLATE DESIGN INSTRUCTIONS – TEXAS BOX

INSTRUCTIONS

WHEN OPENING THE TEMPLATE FILE YOU WILL FIND TWO LEVELS OF WORK

1

LEVEL " TEMPLATE ":

Leave the level locked.

THE LEVEL INCLUDES:

B



CUT LINES:

Cut line, safe area all important artwork should be placed at least 3mm inside the cut line.

C



CREASE LINES:

D



OUTSIDE BLEED:

2

LEVEL YOUR DESIGN:

Insert your graphics into the level, inside the red line, it corresponds to the printable area.



DESIGN:

The file must be a vector or image.

- The file must be placed inside the safe area. (example) E

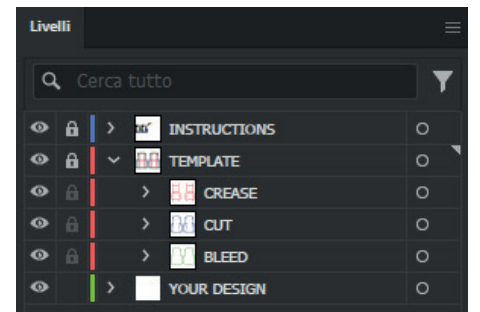
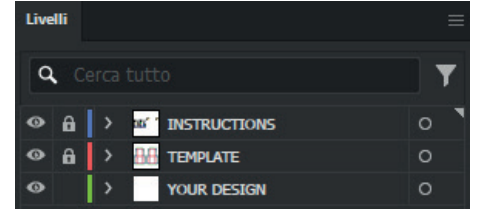

DESIGN IMAGES:

In the basic file sent by the customer, the graphics must be a **vector** or in the case of **images**, they must be attached or incorporated into the final design.



In the case of PNG images we recommend a png format with 300 DPI



COLOR MODE:

Only **CMYK** colours are possible to print



TEXT:

If there is text in your design, you need to convert into a text outline.



FILE FORMATS:

Save the file in pdf in high quality.

- It is important to keep the **TEMPLATE** and **YOUR DESIGN** layers divided

To submit PDF, EPS, AI, PSD, JPG, PNG files at commerciale@ilmyo.it

OUTSIDE CUSTOMIZABLE AREA

DIRECT PRINTING

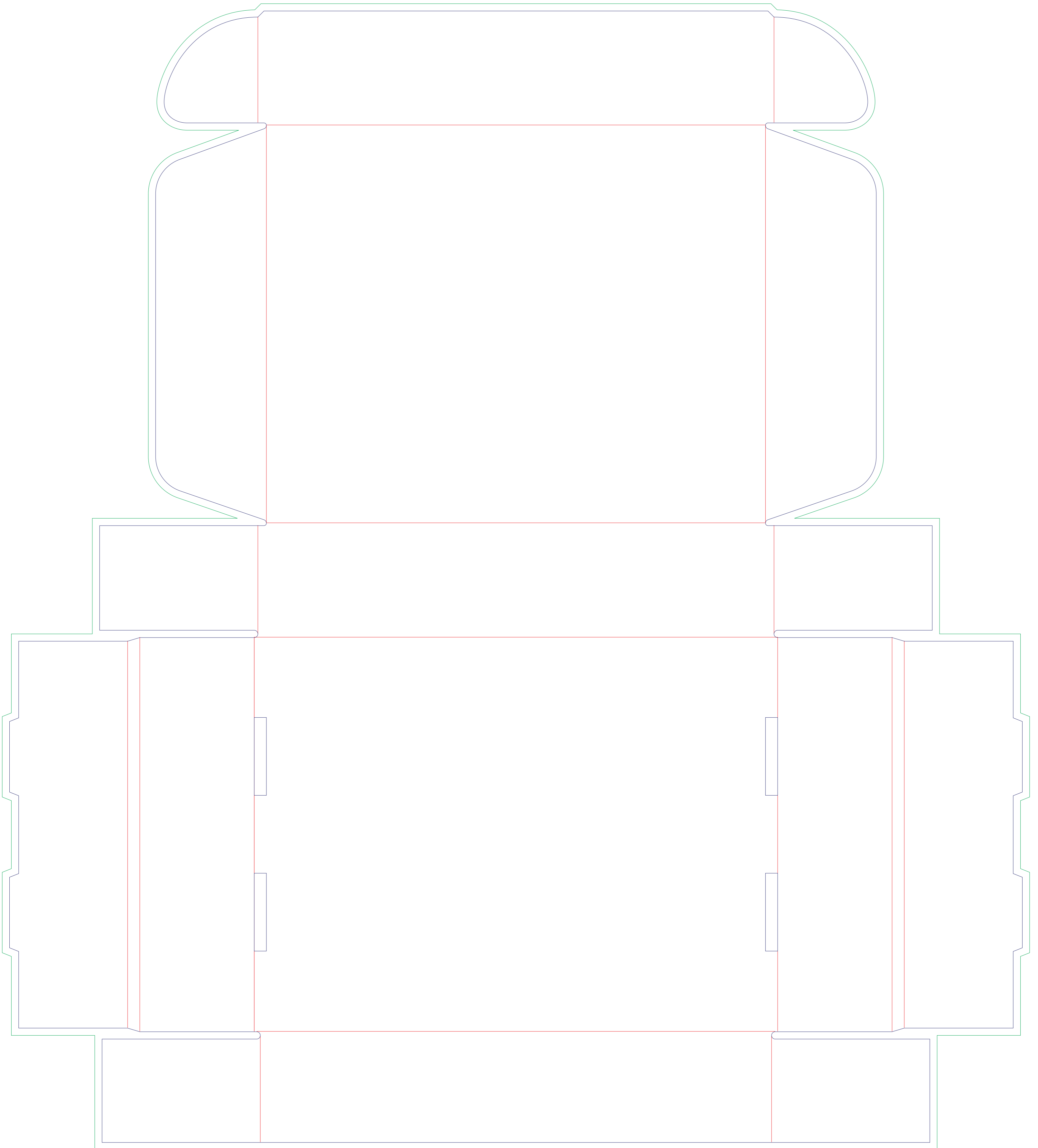

INSIDE CUSTOMIZABLE AREA

DIRECT PRINTING

